

200—550 m
800—1900 m

4201 Z - 9 Ω

103—213 Volt

115 kc/s

47 W.

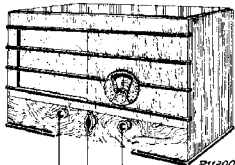

vol.

200—550 m I		200—550 m III		200—550 m V	
vol. max.	135 kc/s-200 pF-g4B1	vol. max.	C9, C10, C11 min.	vol. max.	350 m—Y
R1	C9, C10, C11 min.	R1	1333 kc/s-g4B1		C9, C10, C11 (350 m)
C23, C25, C22, C24			C9, C10, C11 (Le) max.		350 m.
C23, C25 max.			C14 max.		
R1			1333 kc/s—Y		
			C13, C15 max.		
800—1900 m II		800—1900 m III			
115 kc/s—Y		R1	900 m—Y		
C9, C10, C11 1900 m		R1	25 pF—g4B1		
R1			C9, C10, C11 900 m		
C33 min.		R1			
R1					
		Y.R. max.			
		C17 max.			

R1	4700 Ω	48 426 10/47K	C1	32 pF	28 182 40.0
R3	2700 Ω	48 426 10/2K7	C2	32 pF	28 182 40.0
R4	6800 Ω/2	48 427 10/65K	C3	0.5 pF	28 160 21.1
R5	220 Ω	48 426 10/220E	C4	1 pF	28 160 21.1
R6	6800 Ω	48 426 10/65K	C5	47000 pF	48 751 10/47K
R7	680 Ω	48 427 10/680E	C6	25 pF	28 180 02.8*
R8	16000 Ω	48 426 10/10K	C7	25 pF	28 180 02.8*
R9	1 MΩ	48 426 10/1M	C8	25 pF	48 423 10/25E
R10	0.33 MΩ	48 426 10/330K	C9	10-490 pF	
R11	0.56 MΩ	48 426 10/560K	C10	10-490 pF	49 001 14.0
R12	0.60 MΩ	48 426 10/600K	C11	10-490 pF	
R13	1 MΩ	48 426 10/1M	C12	7-55 pF	28 210 44.0*
R14	47000 Ω	48 426 10/47K	C13	7-55 pF	28 210 44.0*
R15	0.5 MΩ	28 008 61.0	C14	7-55 pF	28 210 44.0*
R16	680 Ω	48 426 10/680E	C17	7-55 pF	48 429 02/930E
			C15	930 pF	48 429 02/1K&I
			C16	1616 pF	28 198 40.0*
			C18	25000 pF	28 198 40.0*
			C19	25000 pF	28 198 40.0*
			C22	40-145 pF	28 210 55.0
			C23	40-145 pF	28 210 55.0
			C24	40-145 pF	28 210 55.0
			C25	40-145 pF	28 210 55.0
			C26	0.1 pF	48 751 10/100K
			C27	10000 pF	48 751 10/10K
			C28	2200 pF	48 751 10/2K2
			C29	10000 pF	48 751 10/10K
			C30	200 pF	48 429 10/200E
			C31	150 pF	48 429 10/100E
			C32	0.1 pF	48 751 10/100K
			C33	25-145 pF	28 210 430*

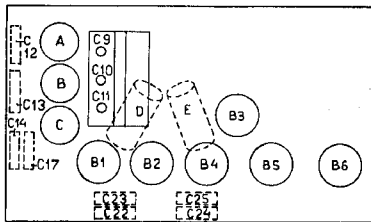

	B1	B2	B3	B4	B5	B6	
	AK 1	AF 2	AB 1	E 446	E 443H	506	
Va	235	235		144	230		V
V _{R2}	67	67		67	219		V
V _{g3+5}	67			—	—		V
V _k	0,94	1,15		2,7	16,8		V
I _a	0,85	1,3		0,3	22,6		mA
I _{g2}	1,20	0,54		0,13	4,45		mA
I _{g3+5}	2,48	—		—	—		mA

81, 82, 83, 84	28 517 00.0*	818, 819	28 517 95.1*
86, 87	28 561 02.2*	820	25 152 44.2*
88, 89	28 561 03.2*		
810, 811, 812, 813	28 561 04.4*		
814, 815	28 561 05.1*		
816, 817	28 561 05.1*		

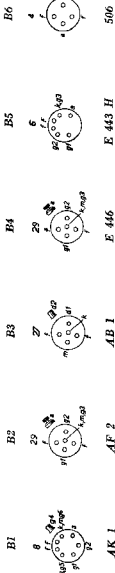
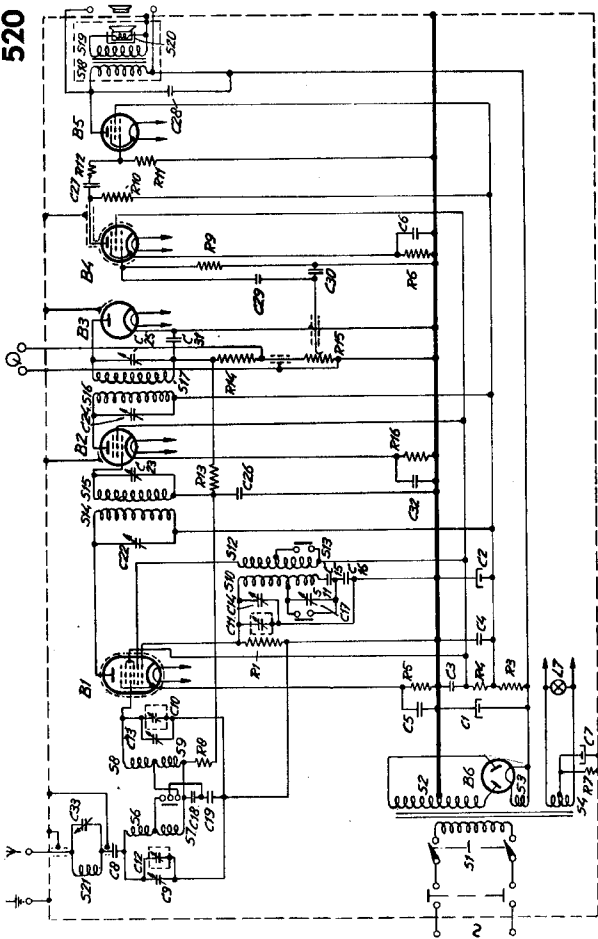

R1310

PHILIPS 520A





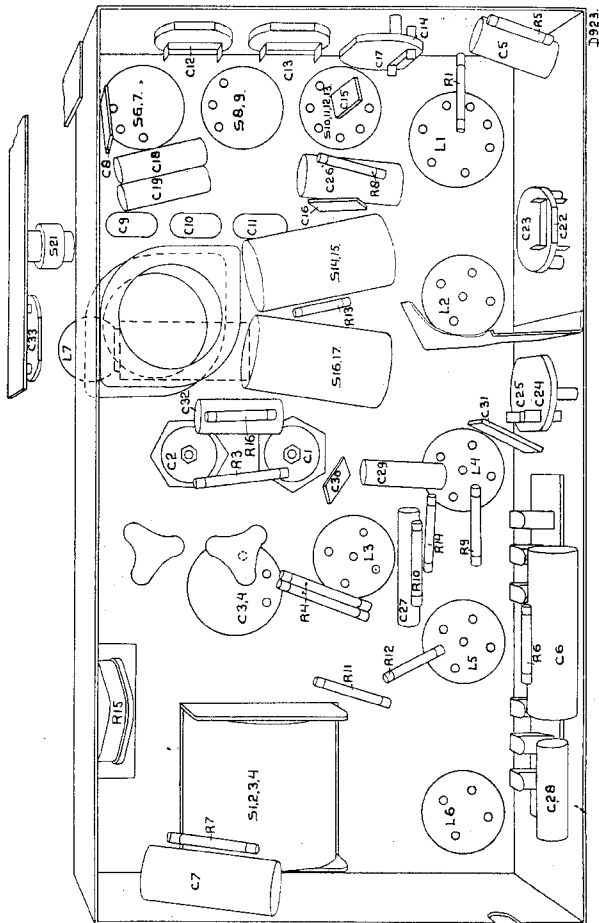

VERTROUWELIJK — CONFIDENTIEL — VERTRAULICH — CONFIDENTIAL

COPYRIGHT 1935

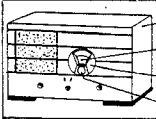
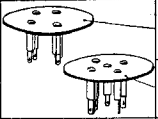
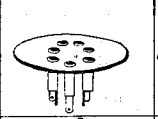
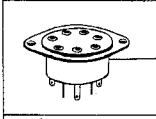
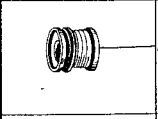
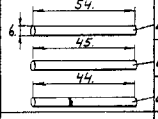
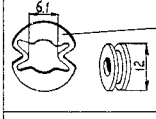
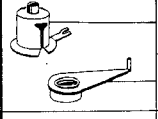
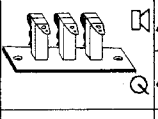
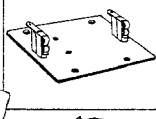
PHILIPS-SERVICE

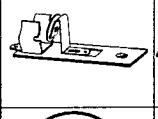
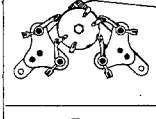
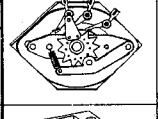
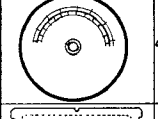

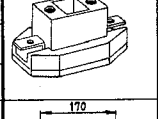
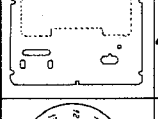
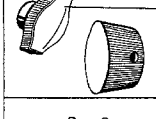
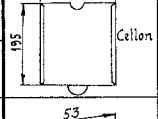
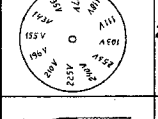
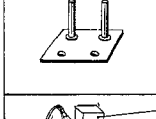
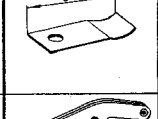
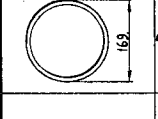
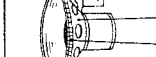
D923.

	25867820 28276831 23999271 25988613		25161320 25161330		28225010
	28225050		25747171		28000041 28000250 28000053
	07891031 28934000		28906021 28852000		25787471 25789570
	28864100		25771191		25160450
	28730010 08527980		08528211		25867810
	25012210 25673860 25655820		25742000		28395042
	23950383 23950190		28908050		28698030
	28864111		25672720		28445400
	28517951 28250440 28445810		25866520 25118710		

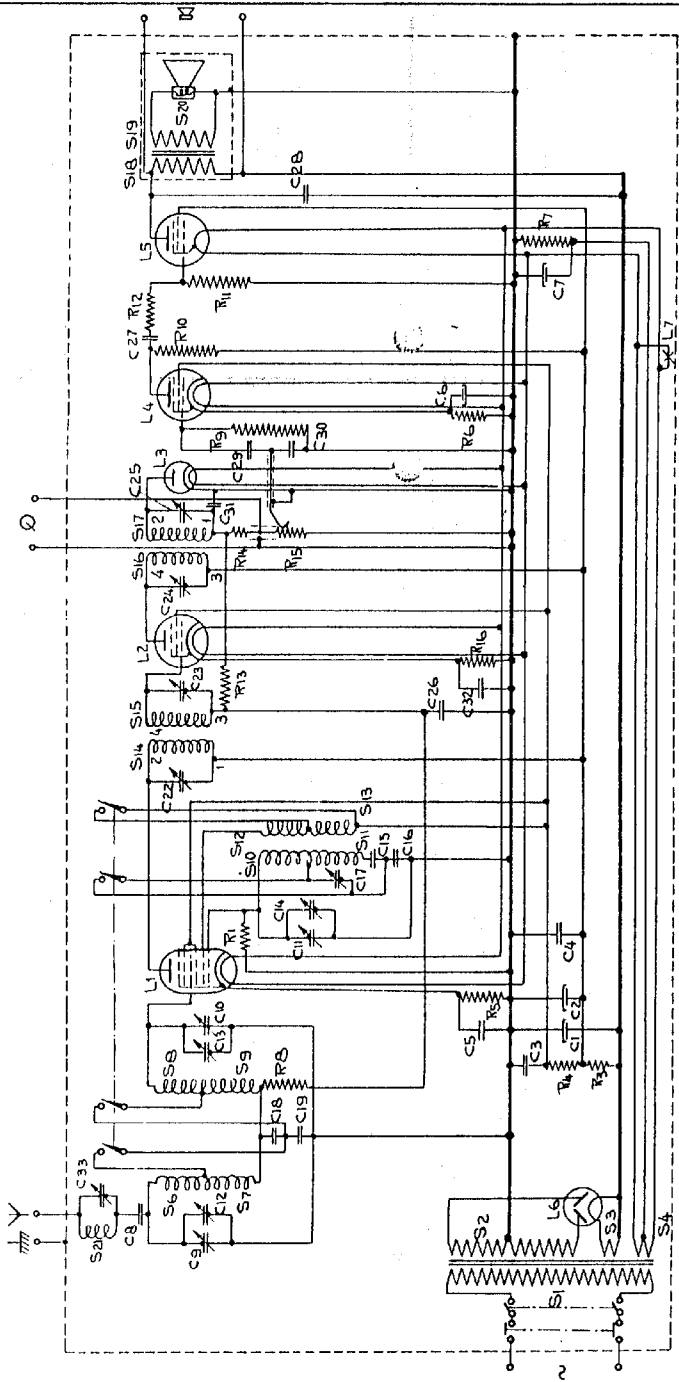

Spanningen en stroomen	Tensions et courants	Spannungen und Ströme	Voltages and currents		
	L1	L2	L4	L5	
Va	226	226	144	228	Volt
Vg'	60	60	59	210	Volt
-Vg	1,1	1,12	2,22	17	Volt
Ia	0,82	1,34	0,28	23,5	mA
Ig'	Ig3+5:3,45 Ig2:1,3	0,59	0,13	9	mA

Waardelijst

Liste de valeurs

Wertliste

List of values

C1	32 μ F	28.180.011	C18	25000 $\mu\mu$ F	28.198.140	R1	50000 Ohm	28.770.420	S1	} 28.517.000		
C2	32 μ F	28.180.011	C19	25000 $\mu\mu$ F	28.198.140	R3	2500 Ohm	28.770.940	S2			
C3	0,5 μ F	28.160.211	C22	40-145 $\mu\mu$ F	28.210.550	R4	64000/2 Ohm	28.771.080	S3			
C4	1 μ F		C23	40-145 $\mu\mu$ F		R5	200 Ohm	28.770.180	S4			
C5	50000 $\mu\mu$ F	28.198.170	C24	40-145 $\mu\mu$ F	28.210.550	R6	6400 Ohm	28.770.330	S5		28.561.022	3,9 Ohm
C6	25 μ F	28.180.020	C25	40-145 $\mu\mu$ F		R7	640 Ohm	28.770.880	S6			36,8 Ohm
C7	25 μ F	28.180.020	C26	0,1 μ F	28.198.200	R8	10000 Ohm	28.770.350	S7		28.561.032	3,9 Ohm
C8	25 $\mu\mu$ F	28.190.070	C27	10000 $\mu\mu$ F	28.198.100	R9	1 M. Ohm	28.770.550	S8			
C9	0-430 $\mu\mu$ F	28.210.140	C28	2000 $\mu\mu$ F	28.198.570	R10	0,32 M. Ohm	28.770.500	S9			9,75 Ohm
C10	0-430 $\mu\mu$ F		C29	10000 $\mu\mu$ F	28.198.100	R11	0,5 M. Ohm	28.770.520	S10		28.561.043	27,4 Ohm
C11	0-430 $\mu\mu$ F	28.210.420	C30	200 $\mu\mu$ F	28.190.160	R12	0,64 M. Ohm	28.770.530	S11			
C12	7-55 $\mu\mu$ F	28.210.420	C31	100 $\mu\mu$ F	28.190.130	R13	1 M. Ohm	28.770.550	S12		28.561.051	10,7 Ohm
C13	7-55 $\mu\mu$ F	28.210.420	C32	0,1 μ F	28.198.200	R14	50000 Ohm	28.770.420	S13			135 Ohm
C14	7-55 $\mu\mu$ F	28.210.440	C33	40-145 $\mu\mu$ F	28.210.540	R15	0,5 M. Ohm	28.808.610	S14		135 Ohm	
C17	7-55 $\mu\mu$ F		R16	640 Ohm	28.770.230	S15	28.561.051	135 Ohm				
C15	930 $\mu\mu$ F	28.190.291			S16	28.561.051	135 Ohm					
C16	1810 $\mu\mu$ F	28.190.302			S17		135 Ohm					
					S18	28.517.951	480-590 Ohm					
					S19		0,66-0,78 Ohm					
					S20	25.152.441	4,35-5,3 Ohm					
					S21	28.561.271	127 Ohm					