

9001/h

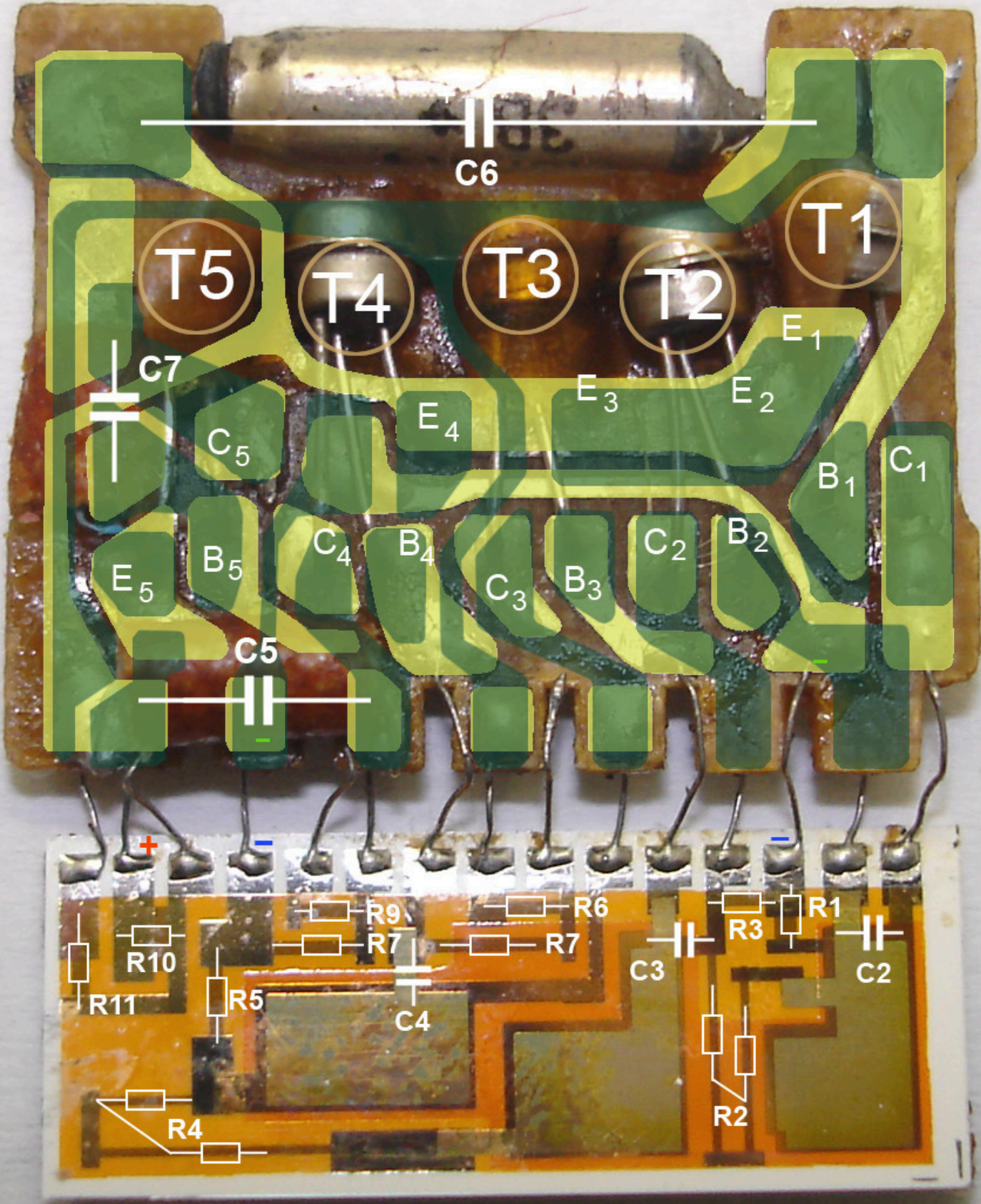

○ = mittels Bauteildraht durchverbunden

Bestückungsseite

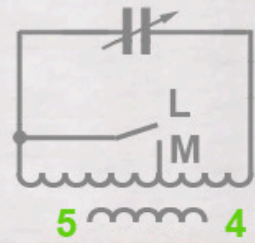
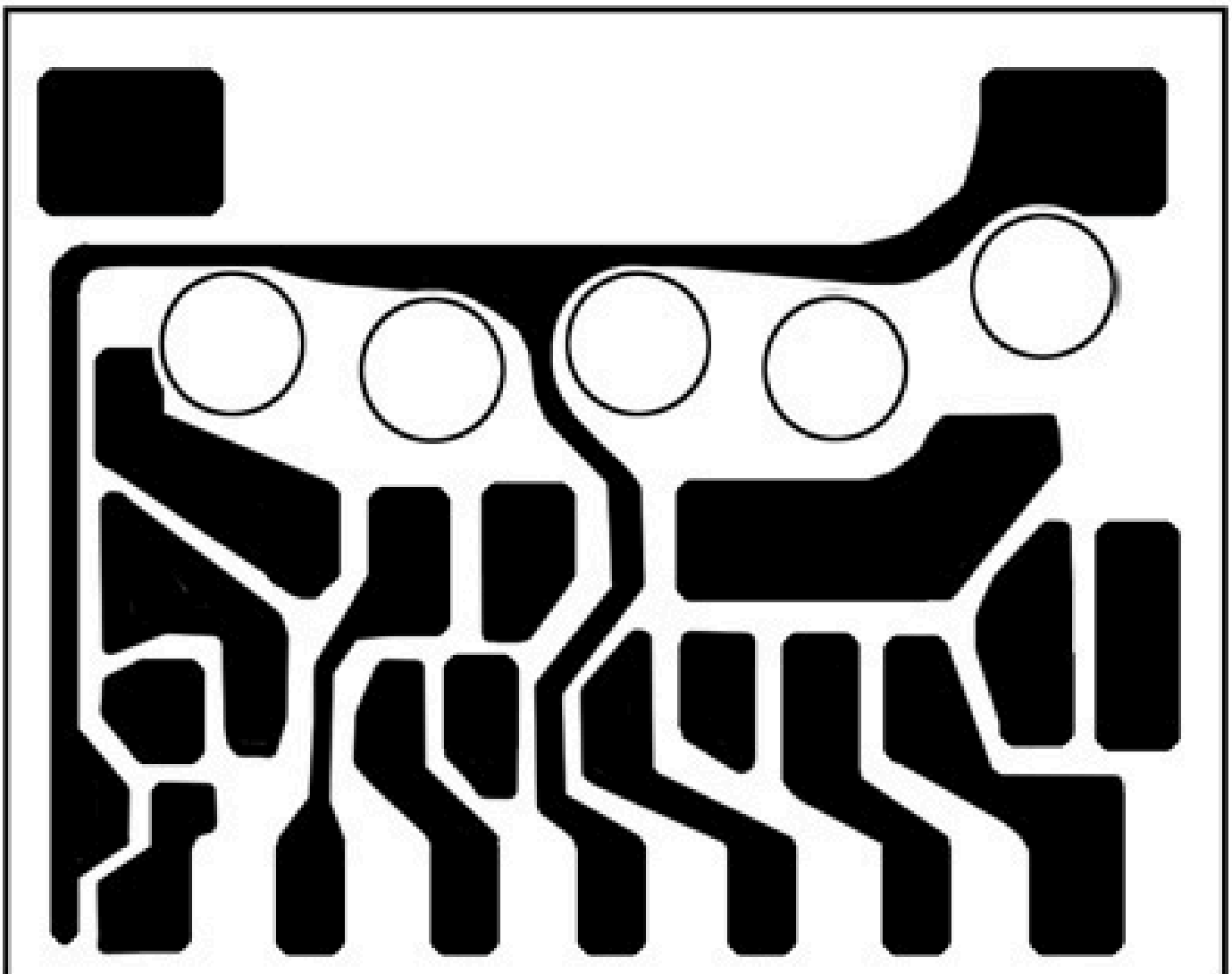
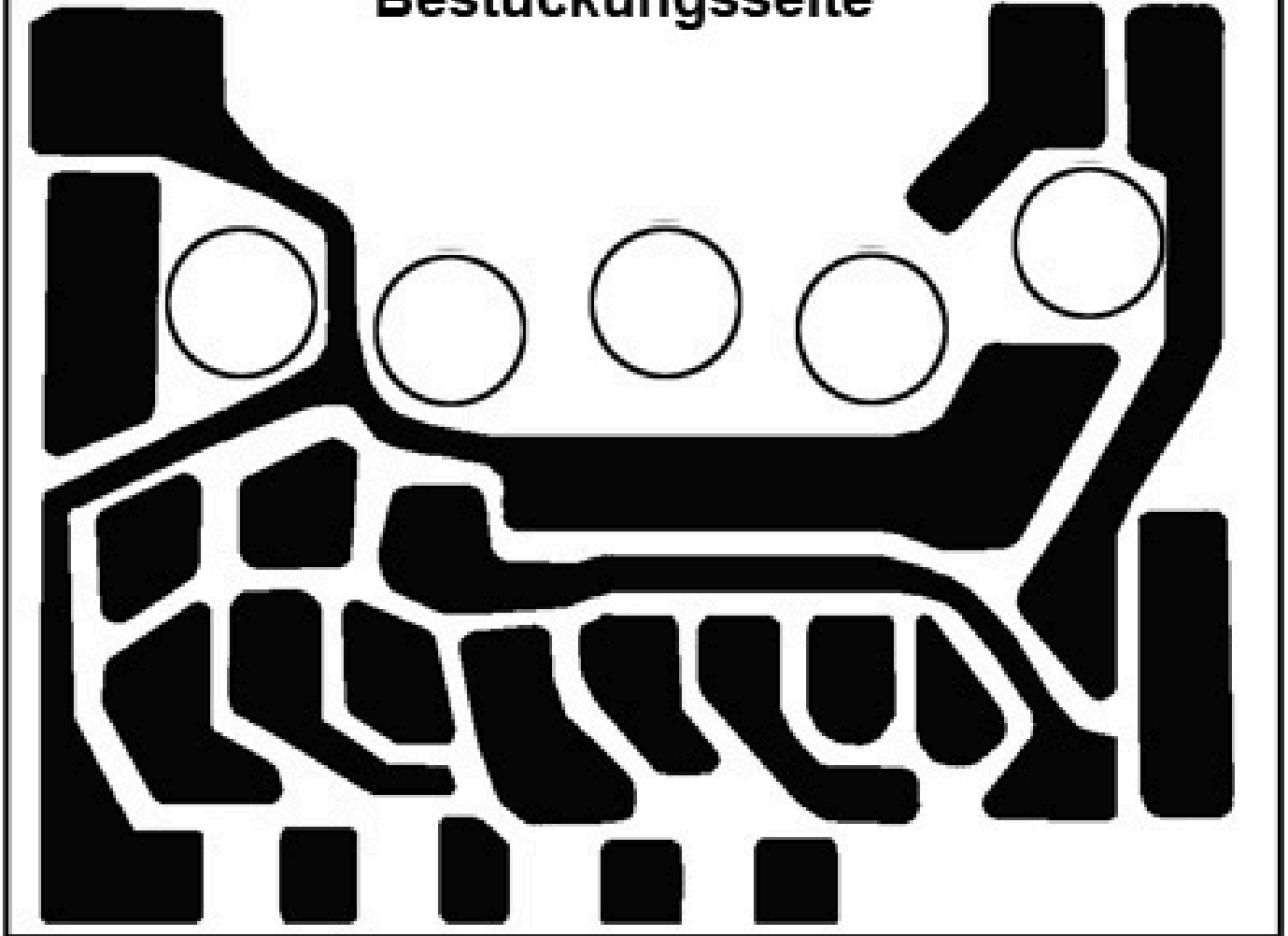

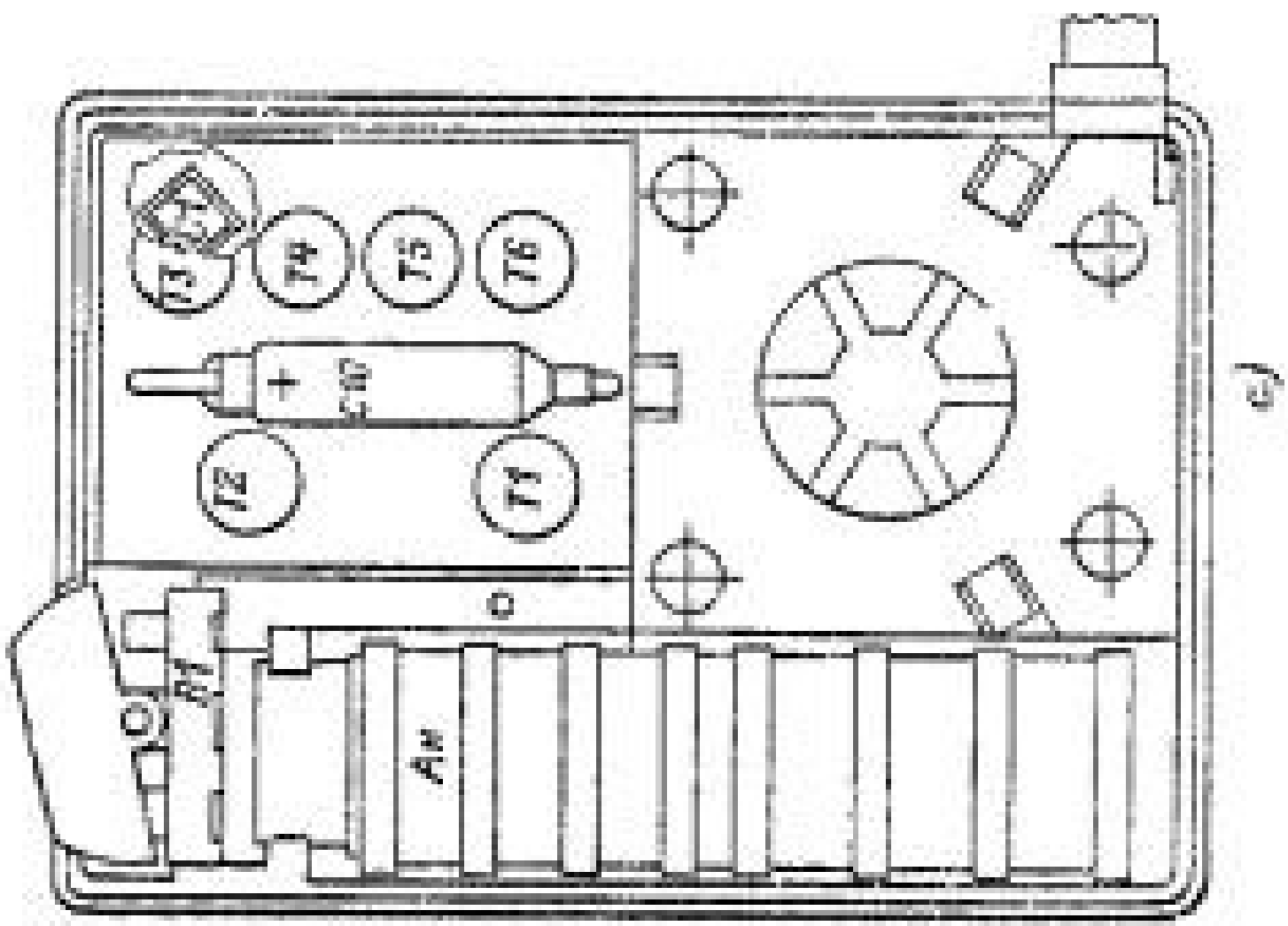
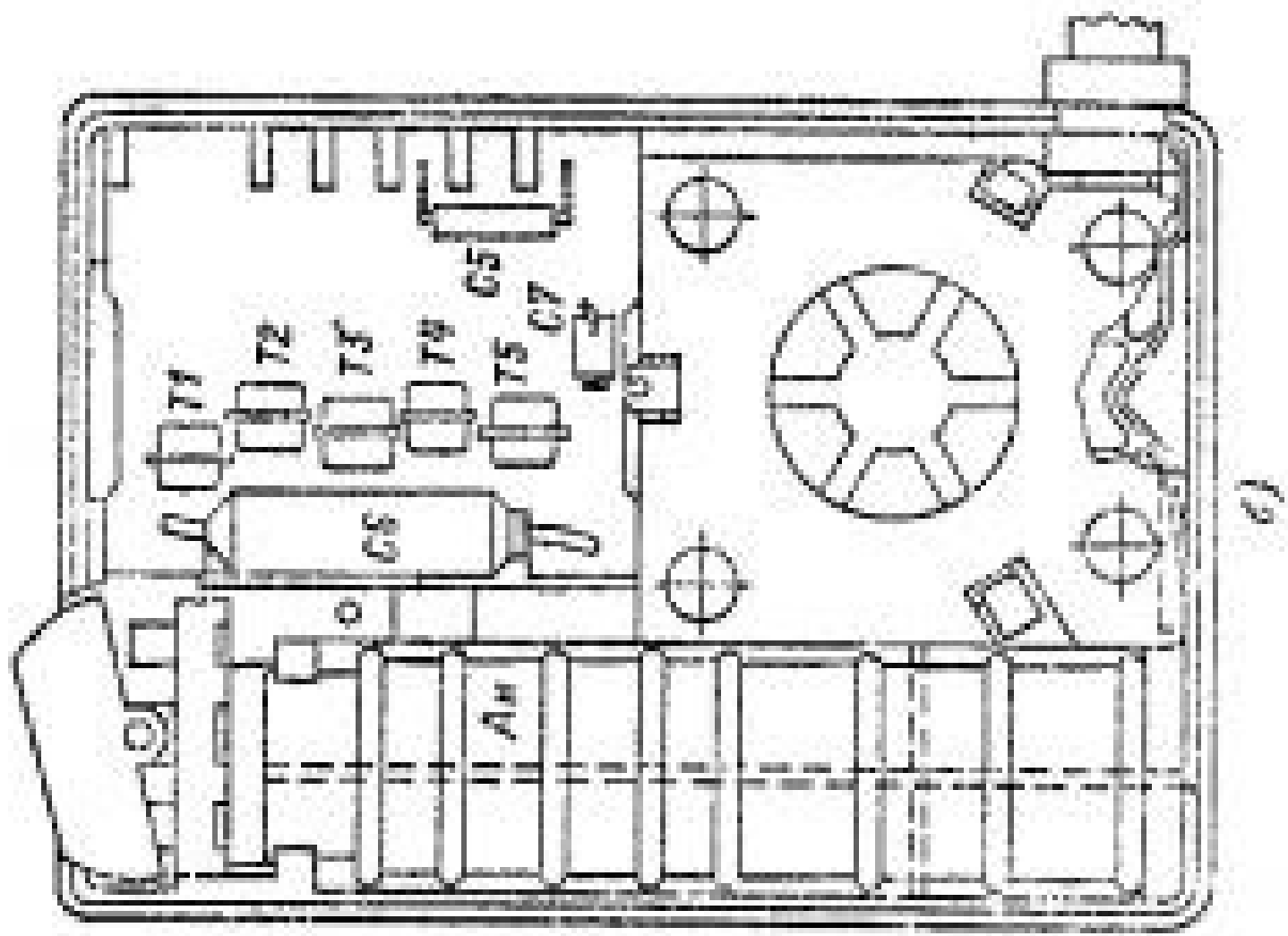



Munkpro



ASTRAD Orion



Munkpro



Miviro



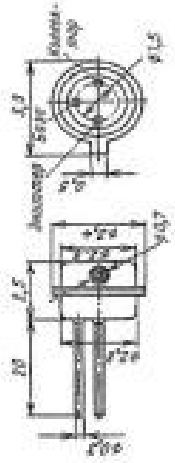
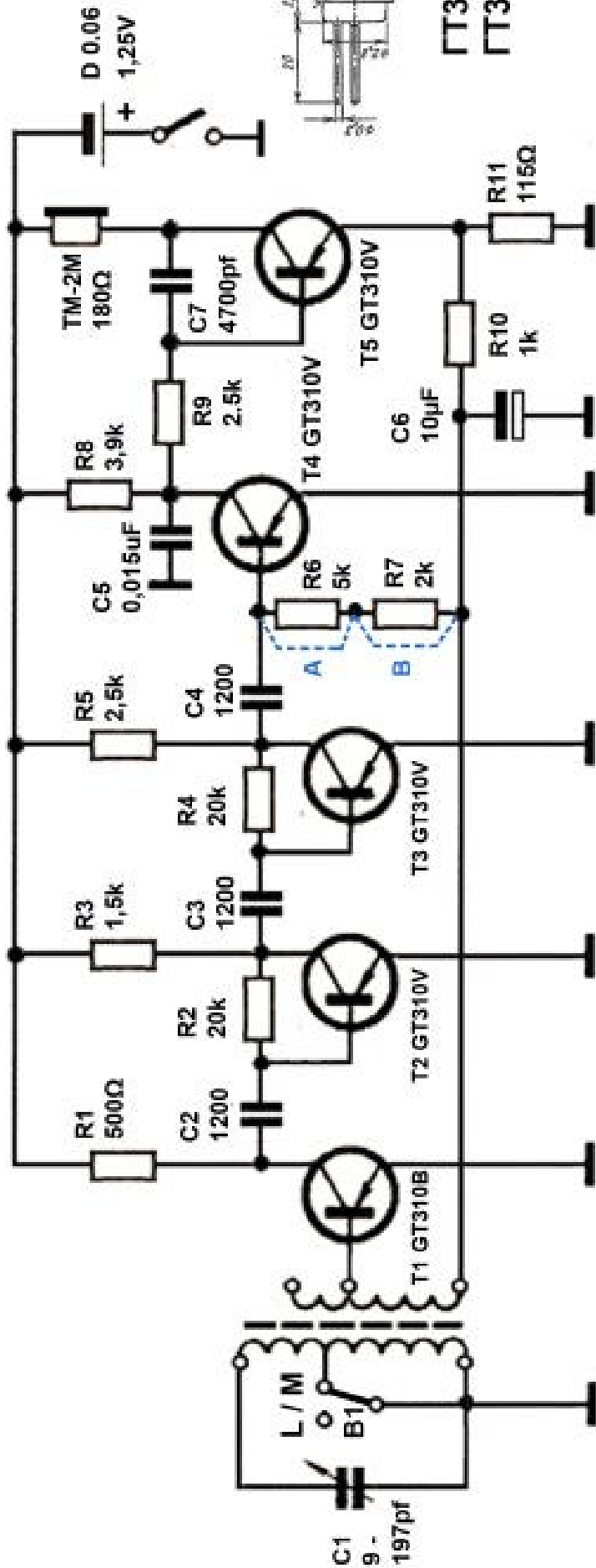

ГТ310Б = GT310B
ГТ310В = GT310V